

PRECISION LASER DIES

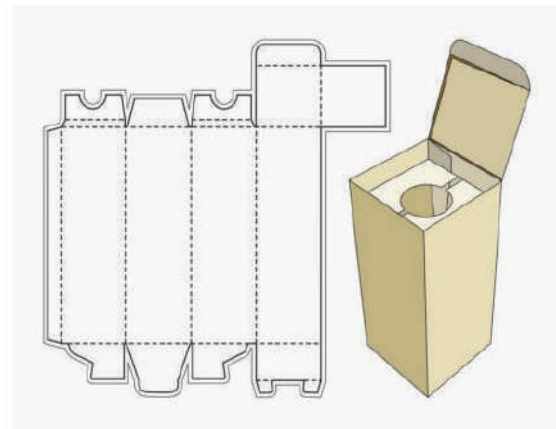

COMPANY PROFILE

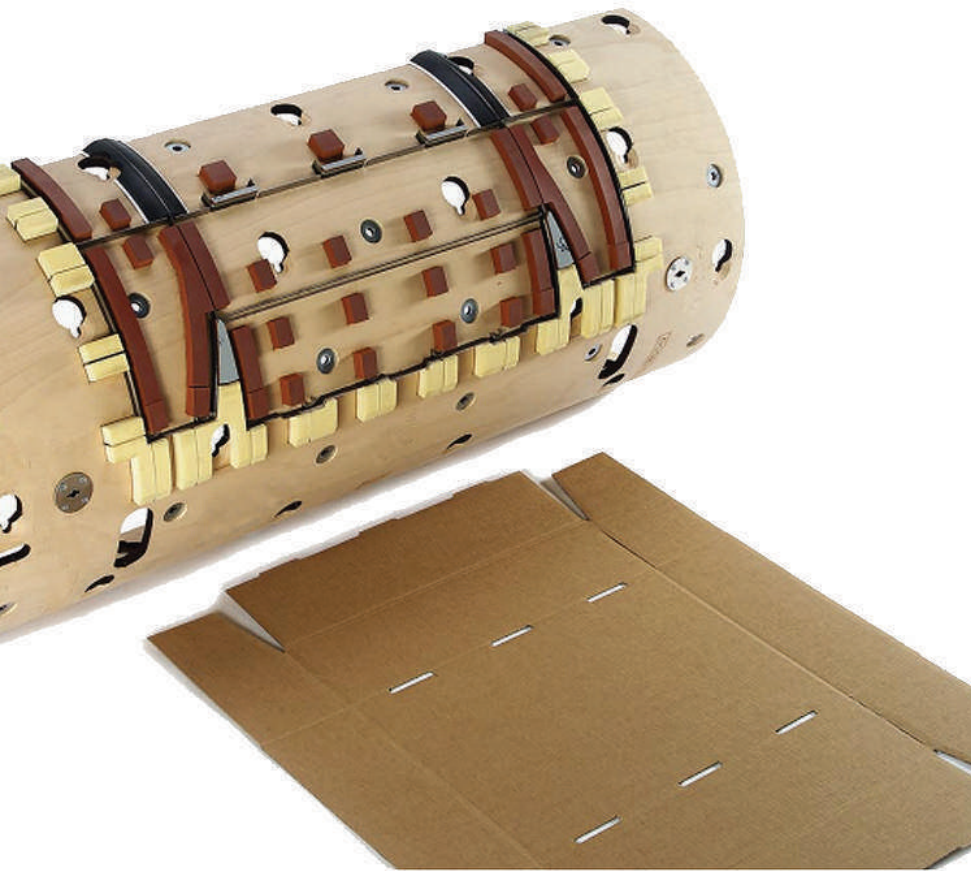
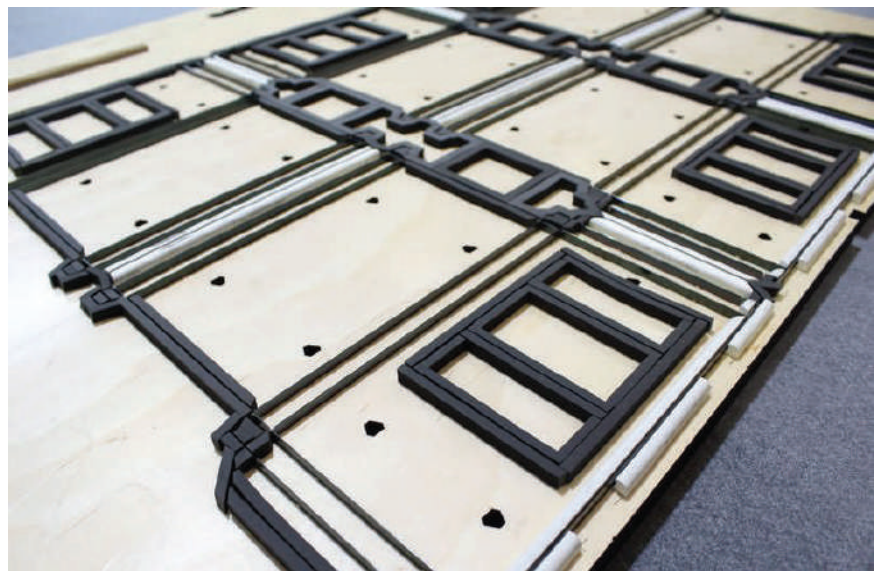

ABOUT US

At Die Cutting Experts we produce precision laser dies for printers of inner cartons and corrugated boxes to replace either hand-made or imported laser dies. The arrival of Die Cutting Experts into the region allows printers to reduce costs, reduce imports, reduce delivery times while improving their product quality and the efficiency of their customers packing lines.

Our team has over 20 years experience in die making in Lebanon and combines with our state of the art German Rofin laser technology to engrave precision rotary and flat dies. We work closely with our customers to increase their die cutting speed and efficiency through quality dies, personnel training and machine optimization.



FLAT DIES

Flat dies are predominantly used in the inner carton packaging industry where accuracy, repeatability and stripping are key to production speeds that allow FMCG automated packing line to run uninterrupted.

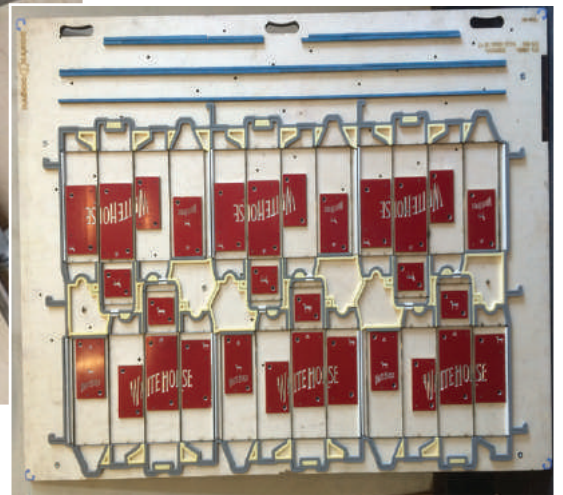
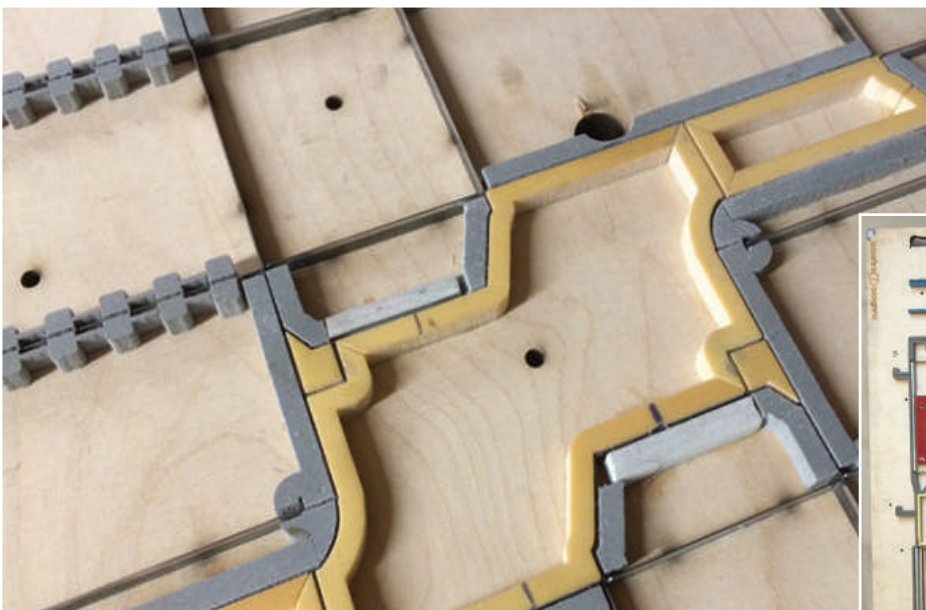
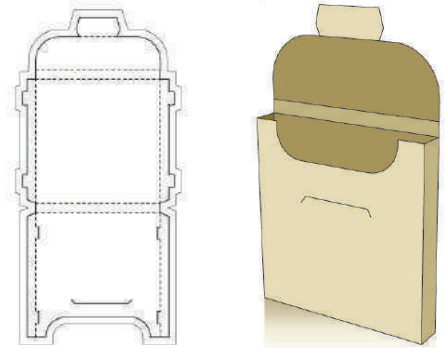

ROTARY DIES

Rotary dies are predominantly used in the outer carton packaging industry for corrugated cartons. The life and quality of any die is driven by 3 key factors – wood and rule quality and the experience of the die maker.

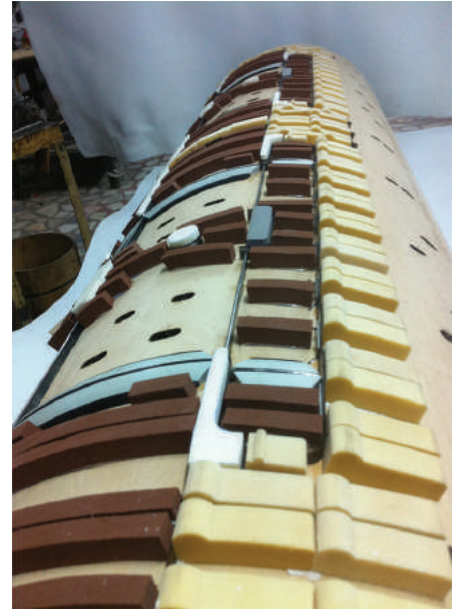
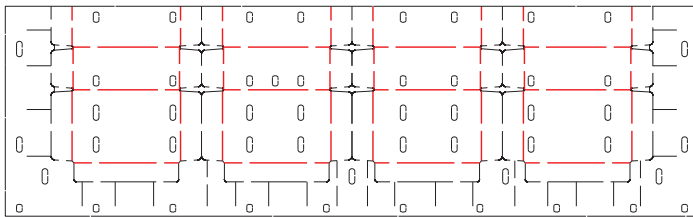

STRIPPING & PERTINAX DIES

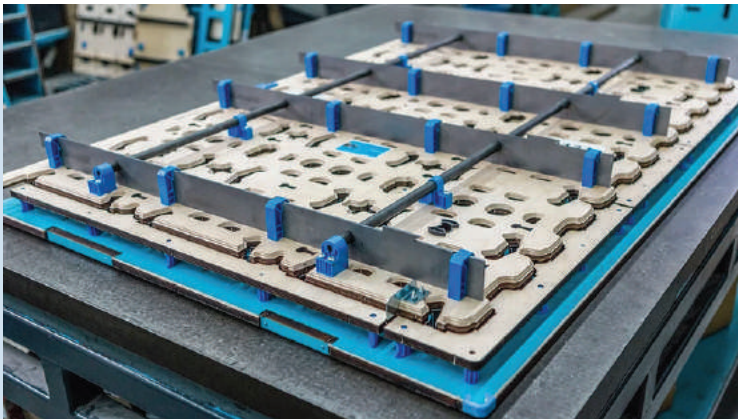

We manufacture stripping dies to speed up the accuracy and productivity of separating the final carton from the surrounding waste. A stripping die will improve print productivity by up to 30%, with reduced costs and give the client greater packing efficiency.

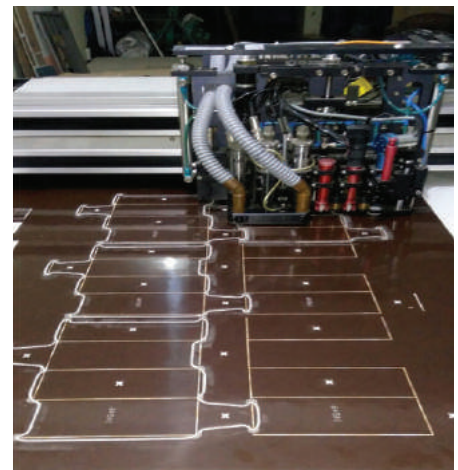
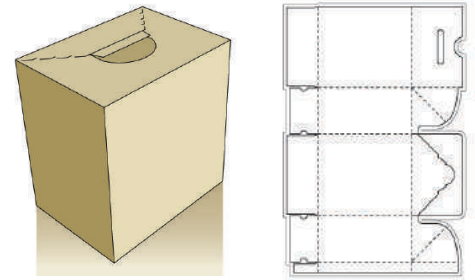

SAMPLE MAKING

We develop unique packaging ideas for products of all shapes and sizes and make life size sample boxes for testing, research and client approval. In addition we make retail display POS systems with no minimum order quantity. Challenge us with your product to pack!

Pertinax, (sometimes known as Phenolic parts or Rilma) is a specialized solution for small inner carton production (i.e. eye & ear drop boxes) where the use of matrix is not accurate. A Pertinax solution allows for precision in small folding boxes.

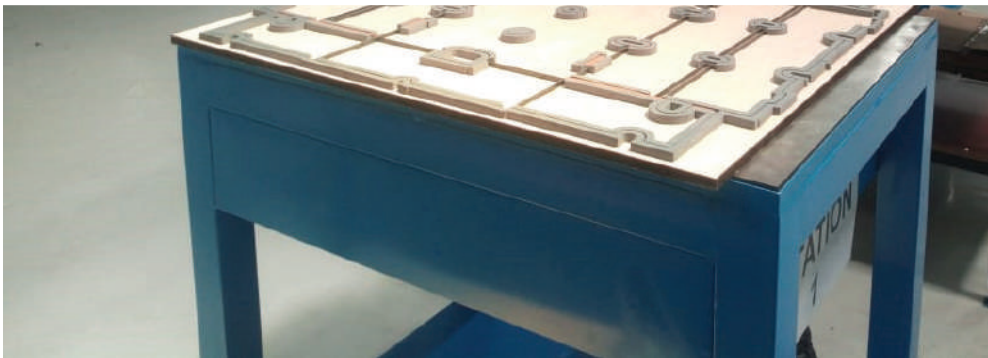
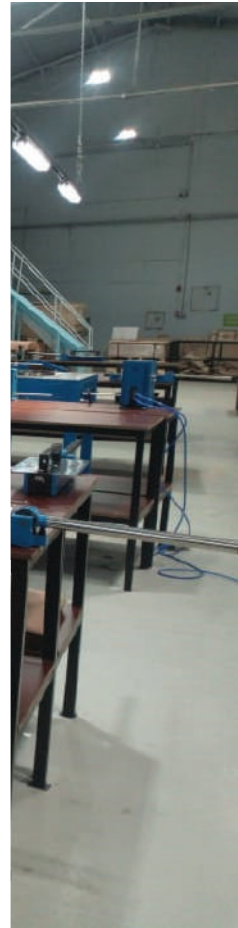

We believe honest communication, teamwork and technology drive production efficiency and we seek similar minded partners to grow together.

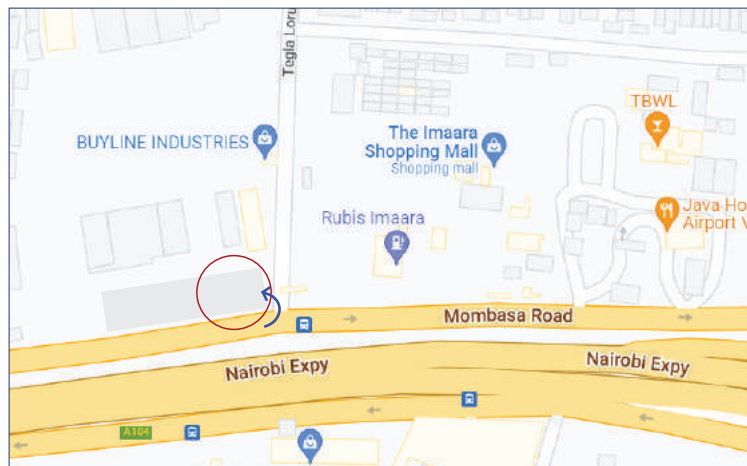

CONTACTS

Location: Mombasa Rd, Nairobi, Kenya
Imara Daima Junction
P.O. Box 38463-00623 Nairobi Kenya
Tel: +254 110 884 472
Email: team@die-experts.co.ke
Website: www.die-experts.co.ke

ArtiosCAD
Impact
Engview Systems